



ASSEMBLY INSTRUCTIONS/ LES INSTRUCTIONS D'ASSEMBLAGE

Armless Chair / Fauteuil sans bras : 99201-AC





Thank you for purchasing this product from Mazin Furniture. Please take the time to read and follow the instructions bellow. Check that you have all parts and hardware before assembly. Parts apparently missing are often found in the packing materials. If you do not have all the parts listed, have your dealer contact us and they will sent to you immediately.

Merci d'avoir acheté ce produit de Mazin Furniture. Veuillez lire et suivre les instructions ci-dessous. Vérifiez avant le montage que vous avez toutes les pièces et fixations. Les pièces qui semblent manquer se trouvent souvent dans les matériaux d'emballage. Si vous n'avez pas toutes les pièces de la liste, demandez à votre détaillant et nous vous les enverrons immédiatement..

PARTS LIST / LIST DE PIECES

A		1pc	Armless chair / Fauteuil sans bras
---	---	-----	------------------------------------

HARDWARE LIST / LIST DE QUINCAILLERIE

C		1pc	Connector plate / Plaque de connecteur
D		1pc	Connector plate / Plaque de connecteur
E		2pc	Connector plate / Plaque de connecteur
F		8pc	Screw / Vis

POSSIBLE VERSIONS / VERSIONS POSSIBLES

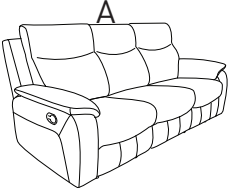
		Sofa / Sofa inclinable
--	---	------------------------

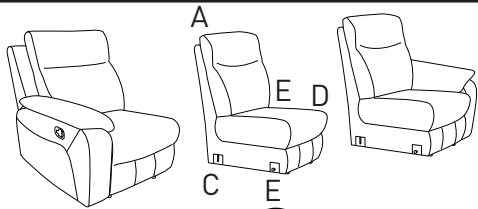

Step 1 / Etape 1:



D,E - Fixed by factory / Fixé par usine

F screw -- move from C connector (1) to reset into C connector's hole of (2) / Passer du connecteur C (1) à la réinitialisation dans le trou du connecteur C de (2)

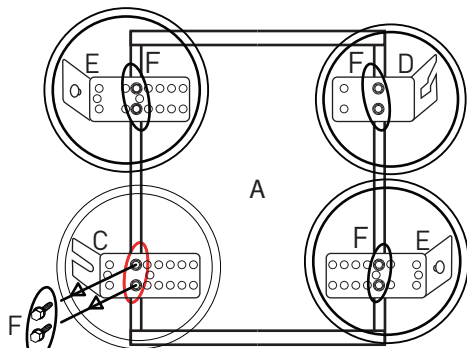

Bottom / Bas

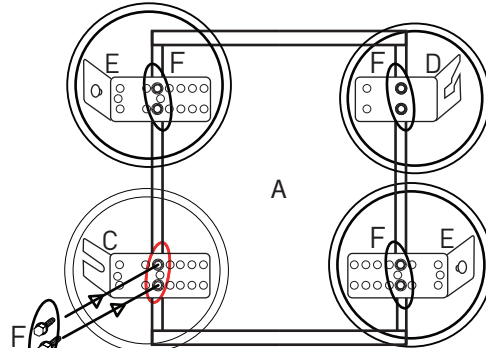

Bottom / Bas

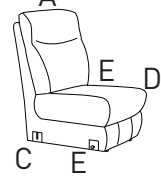
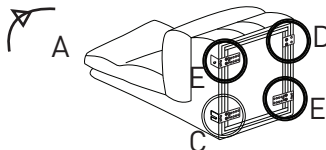
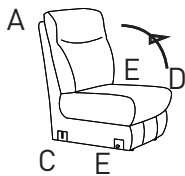

Step 2/ Etape 2:

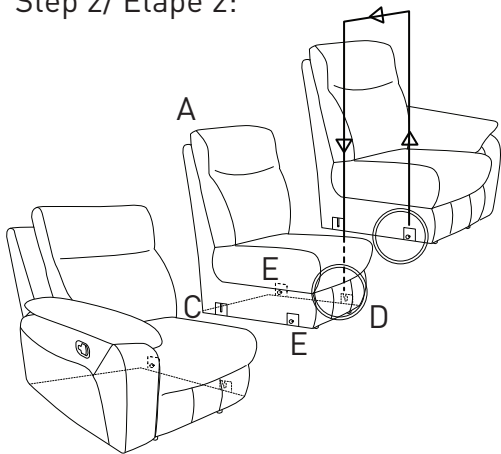

Step 3 / Etape 3:

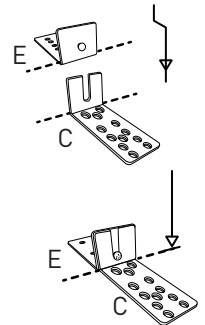
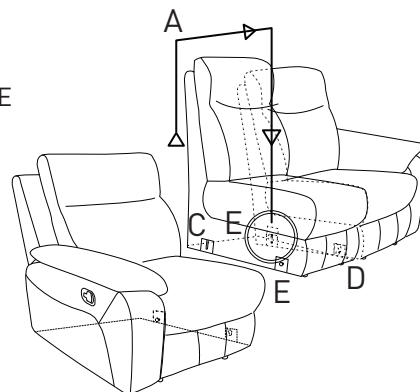
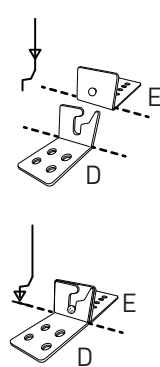

CARE INSTRUCTION FOR LEATHER:

In order to maintain the original appearance of your leather furniture, please follow the following procedures:

1. Avoid exposing furniture directly to sunlight or heating and air conditioning outlets.
2. Vacuum or wipe with a soft cloth to remove dust.
3. Clean the leather with a professional cleanser.

INSTRUCTIONS POUR LES SOIN DU CUIR:

Pour conserver l' aspect original de vos meubles revêtus de cuir, veuillez procéder comme suit:

- 1.Éviter d' exposer les meubles aux rayons directs du soleil ou aux sorties de chaleur et d'air climatisé.
- 2.Pour enlever la poussière passer l' aspirateur ou essuyer avec un chiffon doux.
- 3.Nettoyer le cuir à l' aide d'un nettoyant professionnel.

 It is recommended to install protective pads under all legs and supports to void damage or scratches when placing furniture on a wood floor or other hard surface, and to limit indentation and prevent discoloration if placing on carpet.

 Il est recommandé de placer des coussins protecteurs sous tous les pieds et toutes les bases desmeubles pour éviter d' endommager ou d' égratigner les planchers en bois ou autres surfaces dures, et pour limiter l' empreinte et empê décoloration quando les meubles reposent sur la moquette.