







**ITEM :** 1820K-1 EK/CK KING HEADBOARD  
 1820K-2 EK/CK FOOTBOARD W/STORAGE DRAWER & SLAT ROLL  
 1820K-3CK SIDE RAIL W/TOP CROWN  
 1820-3 QN/EK SIDE RAIL

Thank you for purchasing this quality product. Be sure to check all packing material carefully for small parts which may have come loose inside the carton during shipment. Identify and count all parts and compare with the Parts List below.





**!** For items use on wooden floor, hard surfaces or carpets, it is recommended to install protective pads under all legs and supports to avoid/prevent from damages/scratches and discoloration.

**!** Pour les articles Utilisés sur un plancher en bois, des surfaces dures ou tapis, il est recommandé d'installer des mordaches de protection sous tous les jambes et prend en charge pour éviter/empêcher de dommages/rayures et la décoloration.

**HARDWARE LIST OF FOOTBOARD  
 HARDWARE PACK IS IN-1820K-2**

NO.	DRAWING	DESCRIPTION	Q'TY
5		Φ5/16"*1-1/2" Bolt	4PCS
6		Φ5/16"Lock Washer	4PCS
7		Φ5/16"*19*2mm Flat Washer	4PCS
8		Φ5/16" Allen Key	1PC
9		#8*1" Screw	18PCS





**HARDWARE LIST OF BED RAIL  
 HARDWARE PACK IS IN-1820K-3**

NO.	DRAWING	DESCRIPTION	Q'TY
10		Φ5/16"*3-1/2" Hanger Bolt	8PCS
11		Φ50Arc Washer	8PCS
12		Φ5/16"*L17 Nut	8PCS
13		Φ5/16" Open Wrench	1PC

**COMPONENT LIST**

	DESCRIPTION	QTY
A	HEADBOARD	1PC
B	HEADBOARD RSF LEG	1PC
C	HEADBOARD LSF LEG	1PC
D	HEADBOARD BOTTOM RAIL	1PC
E	FOOTBOARD	1PC
F	SUPPORT LEG	2PCS
G	FOOTBOARD DRAWER (L&R)	2PCS
H	SIDE RAIL	2PCS
I	SLAT (9 PCS)	1SET
J	SLAT SUPPORT LEG	10PCS

**HARDWARE LIST OF HEADBOARD  
 HARDWARE PACK IS IN-1820K-1**

NO.	DRAWING	DESCRIPTION	Q'TY
1		Φ5/16"*1-3/4" Bolt	8PCS
2		Φ5/16"Lock Washer	8PCS
3		Φ5/16"*19*2mm Flat Washer	8PCS
4		Φ5/16" Allen Key	1PC



**ITEM :** 1820K-1 EK/CK KING HEADBOARD  
 1820K-2 EK/CK FOOTBOARD W/STORAGE DRAWER & SLAT ROLL  
 1820K-3CK SIDE RAIL W/TOP CROWN  
 1820-3 QN/EK SIDE RAIL

Thank you for purchasing this quality product. Be sure to check all packing material carefully for small parts which may have come loose inside the carton during shipment. Identify and count all parts and compare with the Parts List below.

**!** For items use on wooden floor, hard surfaces or carpets, it is recommended to install protective pads under all legs and supports to avoid/prevent from damages/scratches and discoloration.

**!** Pour les articles Utilisés sur un plancher en bois, des surfaces dures ou tapis, il est recommandé d'installer des mordaches de protection sous tous les jambes et prend en charge pour éviter/empêcher de dommages/rayures et la décoloration.

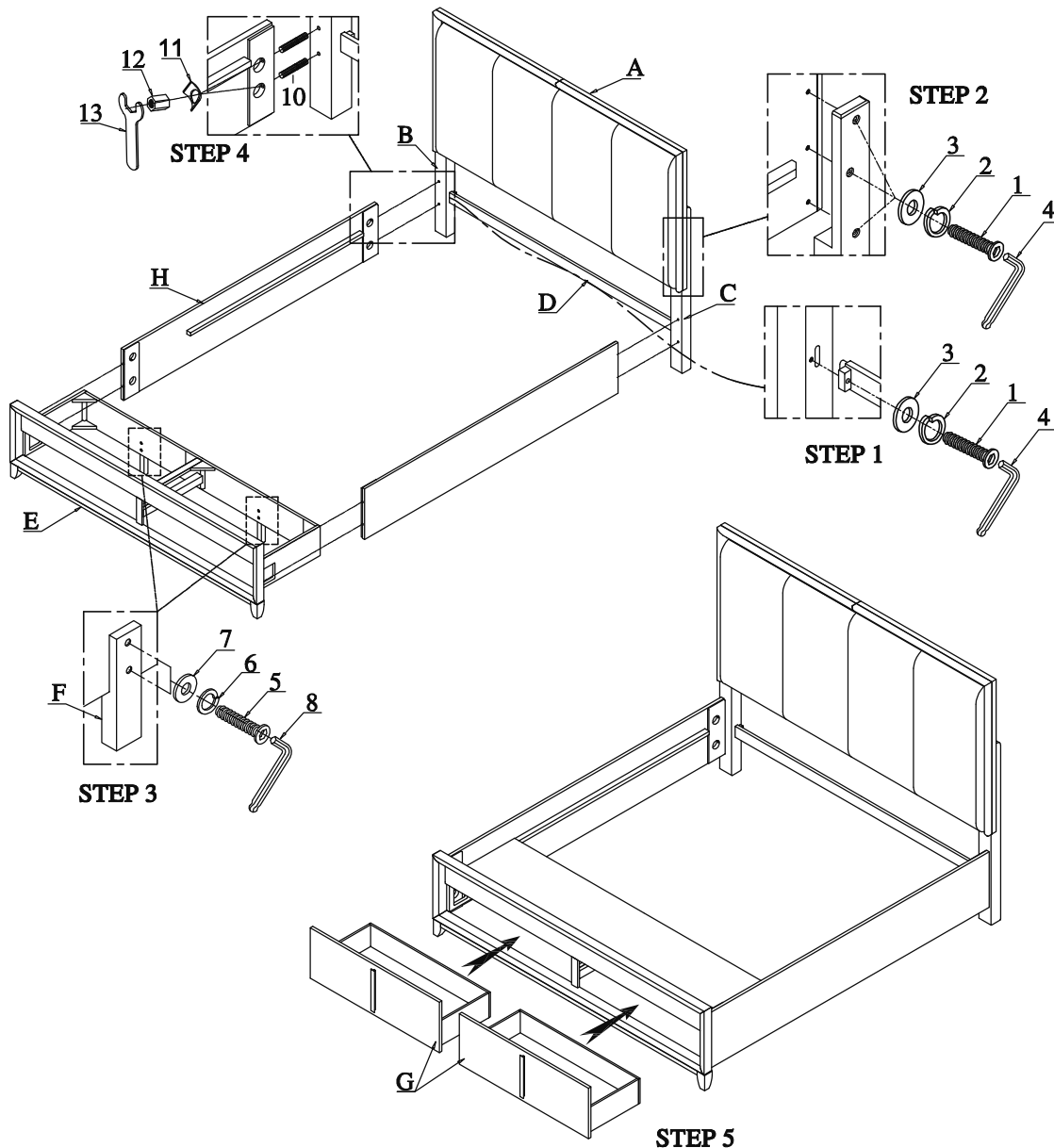



**ITEM :** 1820K-1 EK/CK KING HEADBOARD  
1820K-2 EK/CK FOOTBOARD W/STORAGE DRAWER & SLAT ROLL  
1820K-3CK SIDE RAIL W/TOP CROWN  
1820-3 QN/EK SIDE RAIL

Thank you for purchasing this quality product. Be sure to check all packing material carefully for small parts which may have come loose inside the carton during shipment. Identify and count all parts and compare with the Parts List below.

**!** For items use on wooden floor, hard surfaces or carpets, it is recommended to install protective pads under all legs and supports to avoid/ prevent from damages/ scratches and discoloration.

**!** Pour les articles Utilisés sur un plancher en bois, des surfaces dures ou tapis, il est recommandé d'installer des mordaches de protection sous tous les jambes et prend en charge pour éviter/empêcher de dommages/raures et la décoloration.

