

# ASSEMBLY INSTRUCTION



ITEM NO.:8312NTP-2L  
(1/2) LEFT SIDE 2 SEATER





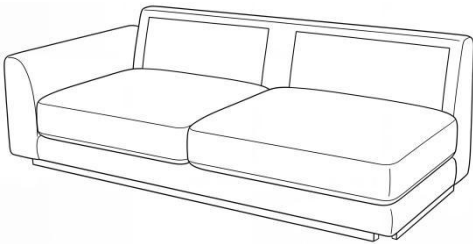
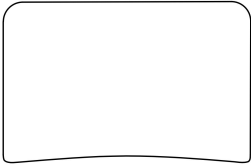
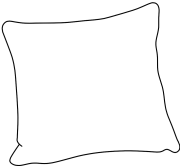
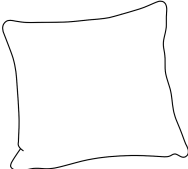
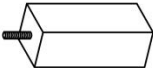

The pillows and back cushions are stored on top of the seat cushions. Wooden legs & hardware bag are stored in the bottom of the seat. Please take them out for assembly.

Note: Do not use power tools for assembly. Power tools increase the risk of over tightening which leads to splitting or cracking the wood.

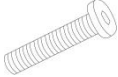
## COMPONENT LIST

No	Drawing	Description	Qty
A		SEAT	1 PC
B		BACK CUSHION	2 PCS
C		PATTERNED PILLOW (19" × 19")	1 PC
D		SOLID PILLOW (19" × 19")	1 PC
E		WOODEN SUPPORT LEG (5cm × 5cm × H 15cm)	1 PC
F		WOODEN LEG (5.5cm × 5.5cm × H 15.5cm)	4 PCS

No	Drawing	Description	Qty
G		PLASTIC WASHER Φ1-7/8"	1PC
H		BOLT Φ5/16"x2-3/8"	8 PCS
I		SPRING WASHER Φ 5/16"	8 PCS
J		FLAT WASHER Φ 7/8"	8 PCS
K		ALLEN WRENCH M5 x 6.5cm	1 PC

Step #1

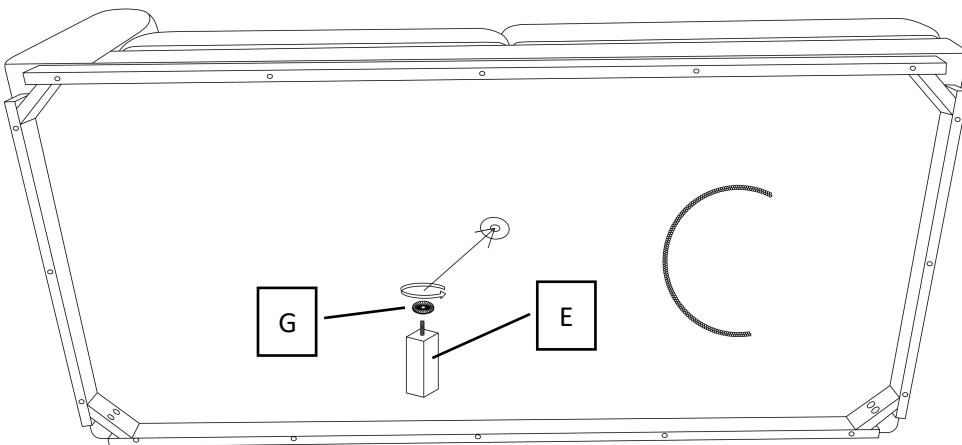
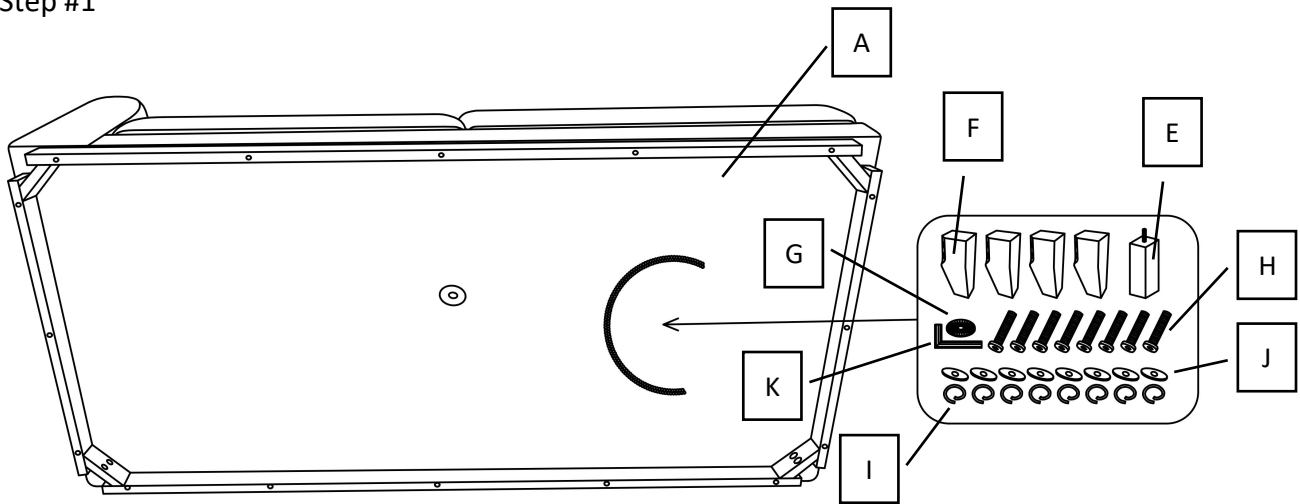

Step #2

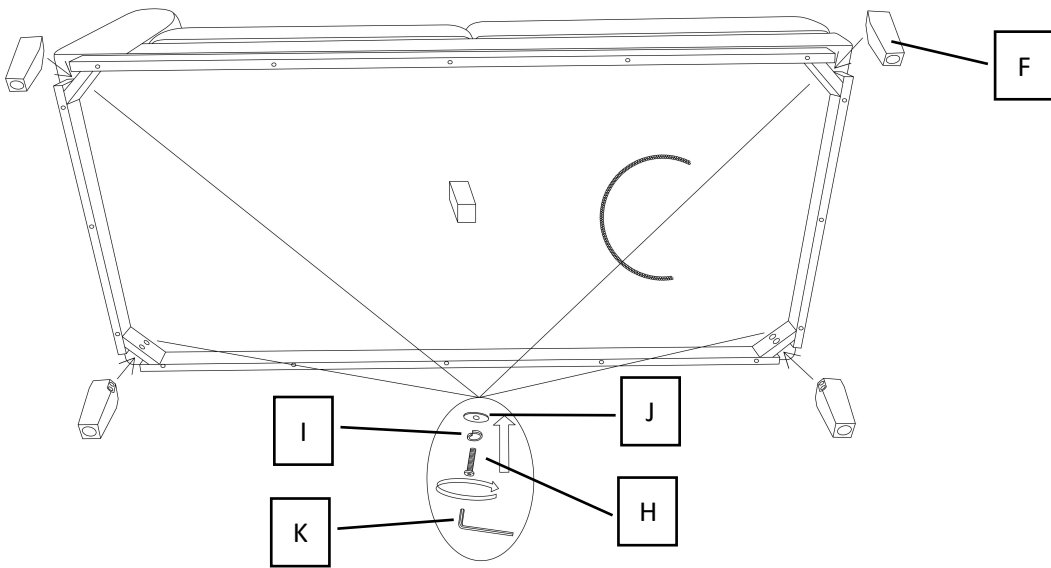

Step #3

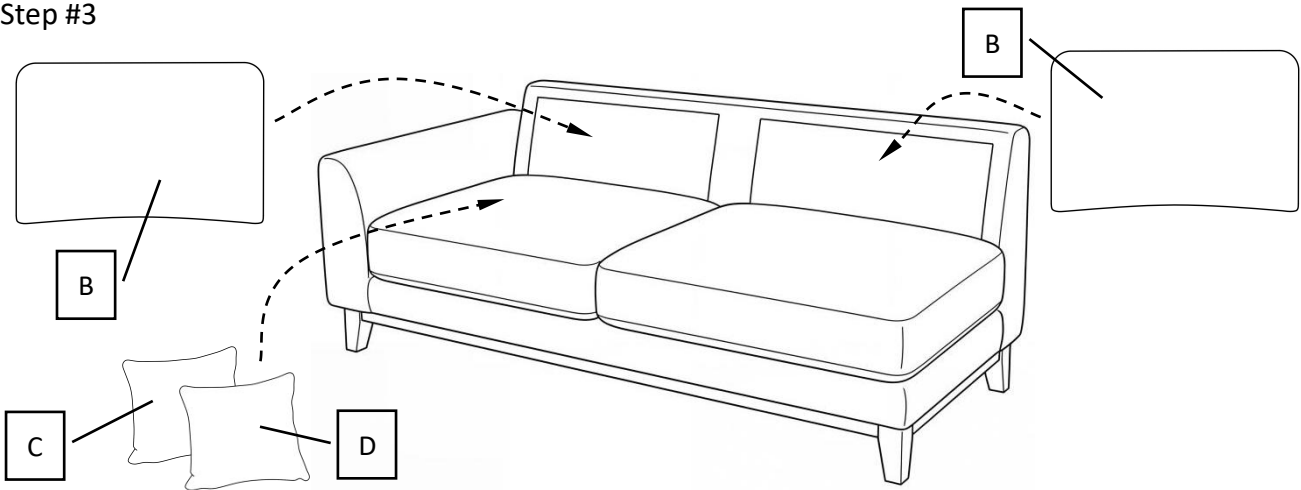

Step #4

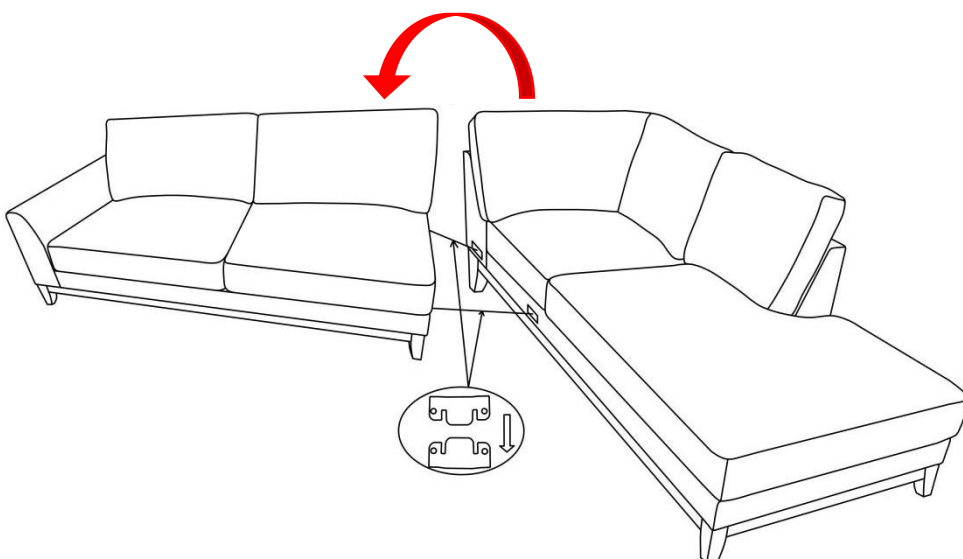

**COMPLETED**

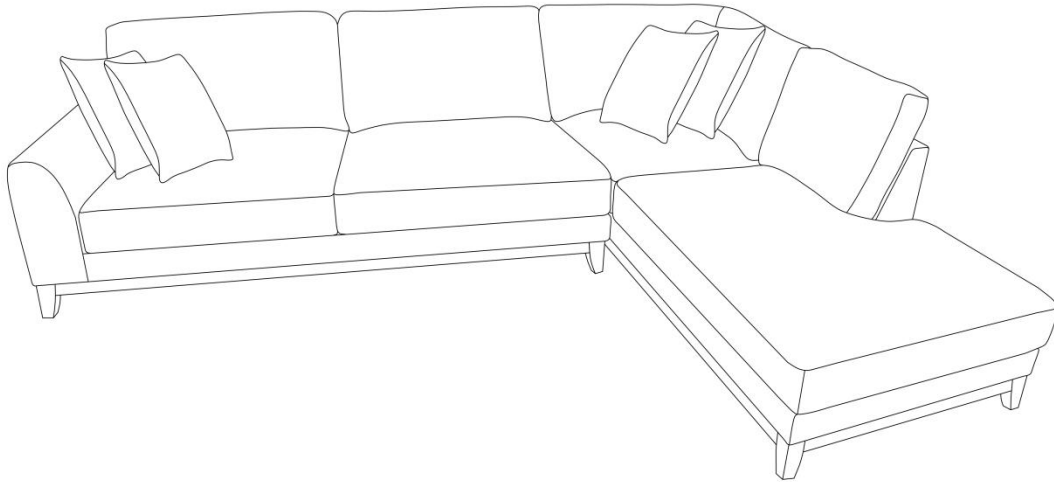

### **Care Instruction for Chenille Furniture:**

To maintain the original appearance of your chenille furniture, please follow the simple care procedures below:

- Avoid exposing furniture directly to sunlight or heating and air conditioning outlets. Sunlight and/or exposure to heating and air conditioning outlets will fade/damage chenille.
- Vacuum or wipe with a soft cloth to remove dust.
- Hardware may loosen over time. Periodically check to make sure all connections are tight. Re-tighten if necessary.



For items used on wooden floor, hard surfaces or carpets, it is recommended to install protective pads under all legs and supports to prevent damages, scratches, and discoloration.