



Assembly Instruction

ITEM NO.: 9348BRW-3

SOFA







H O M E E L E G A N C E



Legs & Arms & Back Cushions in the bottom of seat, please take out for assembly.

Note: Do not use power tools for assembly. Power tools increase the risk of over tightening which lead to splitting or cracking the wood.

Component list

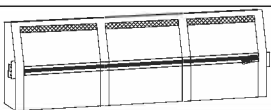
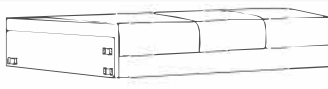
No	Drawing	Qty	Description
A		4	WOODEN LEG H:4.7INCH
B1		1	LSF BACK CUSHION
B2		1	MIDDLE BACK CUSHION
B3		1	RSF BACK CUSHION
C		1	LSF ARM
D		1	RSF ARM
E		1	BACK REST
F		1	SEAT

Step #1

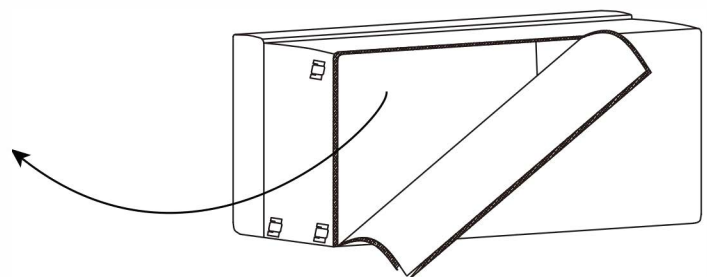
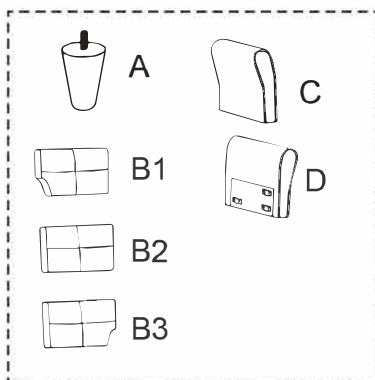

1

Step #2

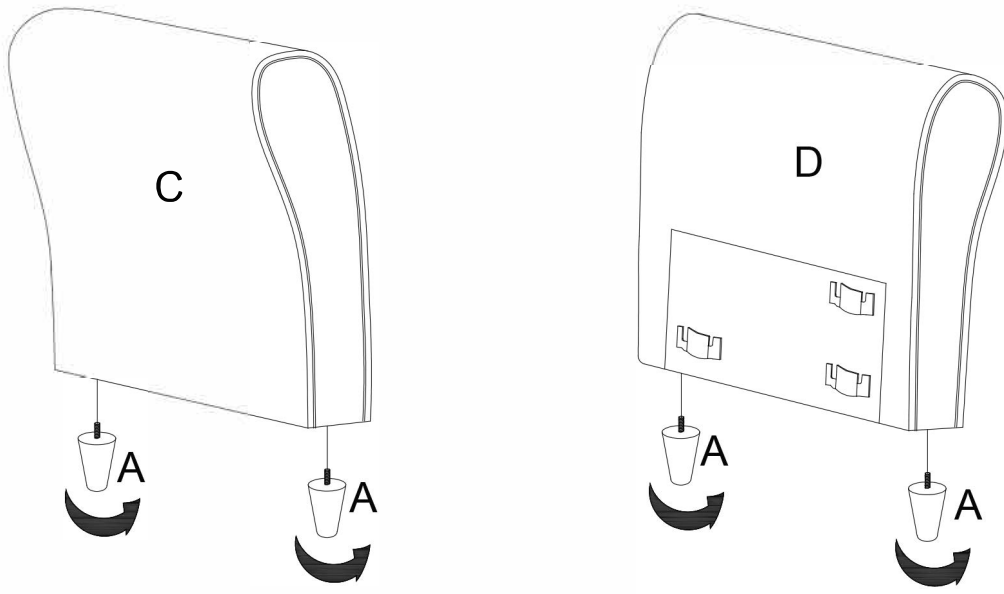

Step #3

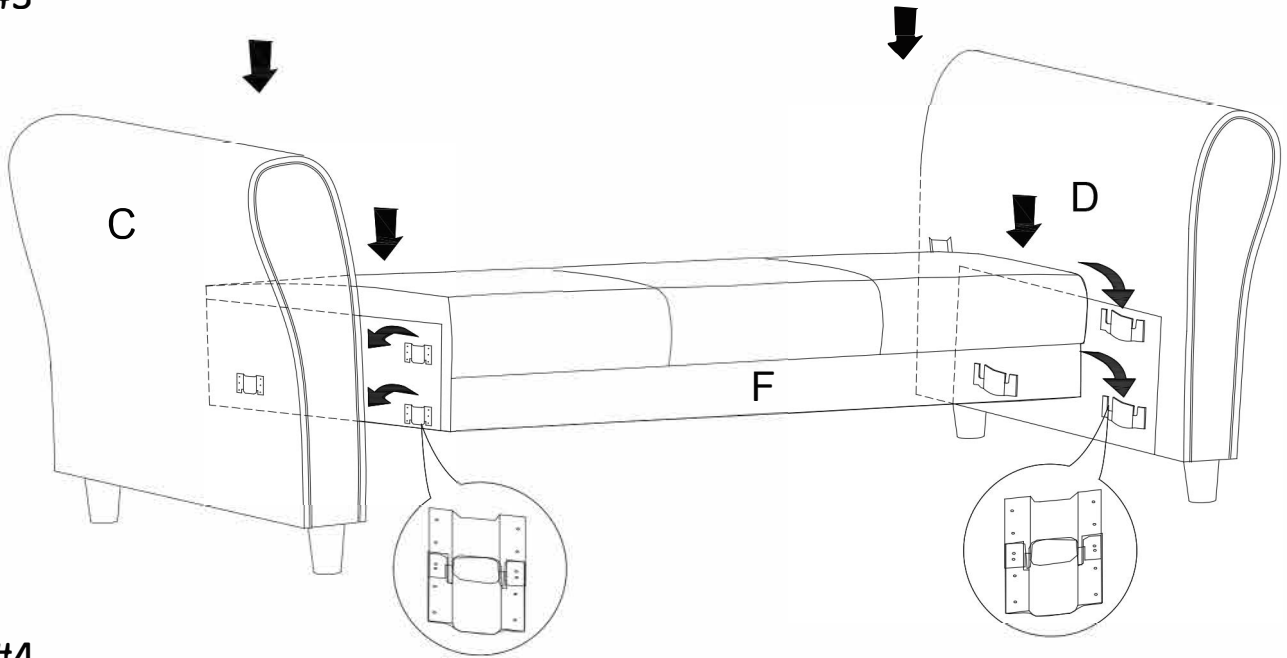

Step #4

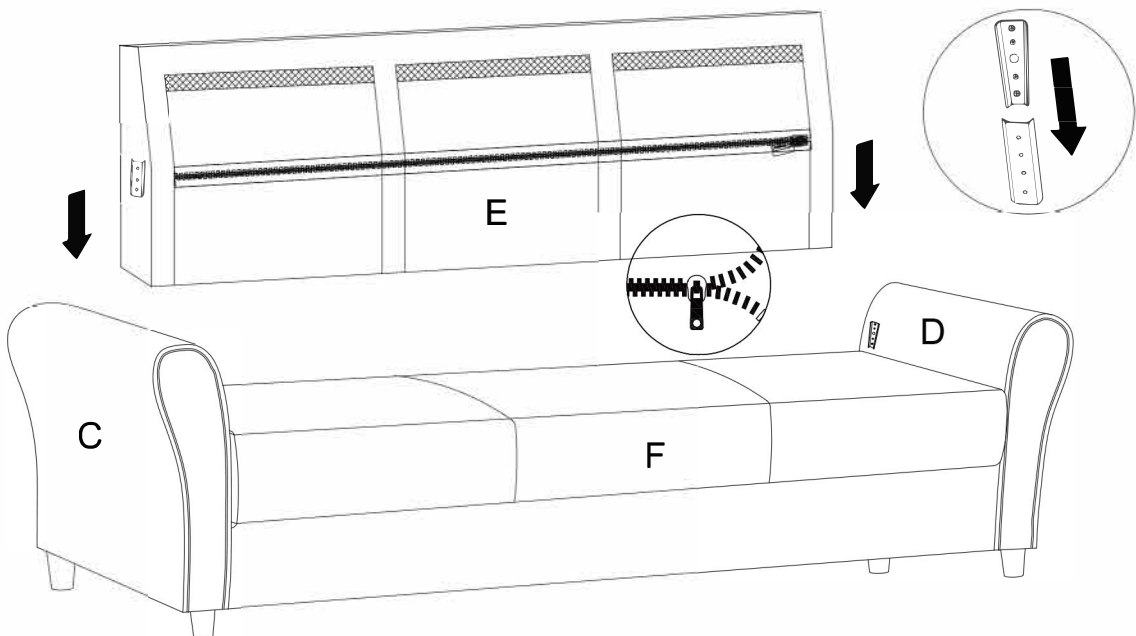

Step #5

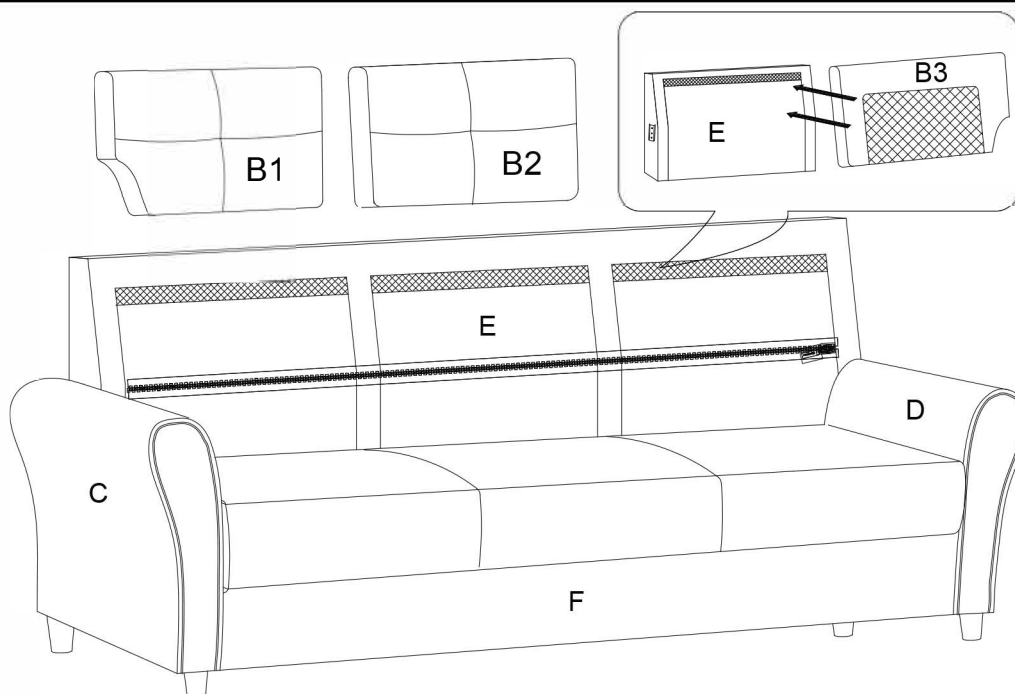

Step #6

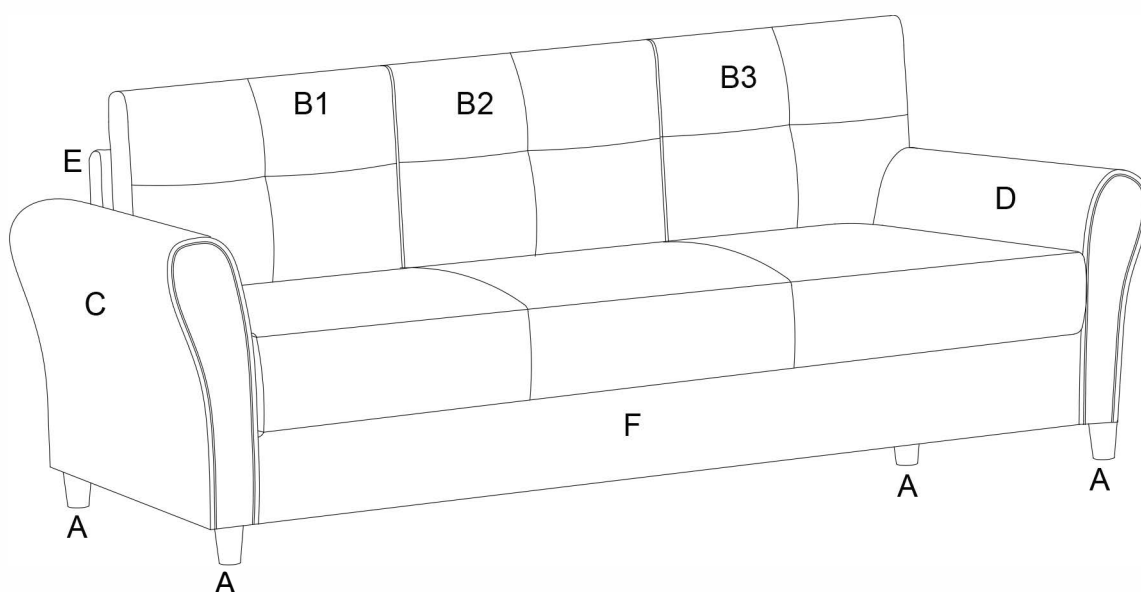

Care Instruction for Velvet Furniture:

In order to maintain the original appearance of your velvet Furniture, please follow below simple care procedures:

- Avoid exposing furniture directly to sunlight or heating and air conditioning outlets. Sunlight and or exposure to heating and air conditioning outlets will fade/damage velvet .
- Vacuum or wipe with a soft cloth to remove dust.



For items use on wooden floor, hard surfaces or carpets, it is recommended to Install protective pads under all legs and supports to avoid/prevent from damages/scratches and discoloration.